

Fail-Safe actuator used in typical Fire and Smoke damper applications

- Torque motor 30 in-lb [3.5 Nm]
- Nominal voltage AC/DC 24 V
- Control On/Off
- @ 350°F [177°C] for 30 min
- 15 s, <15 s Motor/Fail-safe
- 2x SPST



5-year warranty

**Technical data**

<b>Electrical data</b>	Nominal voltage	AC/DC 24 V
	Nominal voltage frequency	50/60 Hz
	Power consumption in operation	15 VA
	Power consumption in rest position	2.5 W, 3.5 VA, End stop 25 VA, 1 A slow blow fuse *
	Transformer sizing	24 VA
	Auxiliary switch	2x SPST, 3 A resistive (0.5 A inductive) @ AC 250 V, one set at 10°, one set at 85°
	Switching capacity auxiliary switch	3 A resistive (0.5 A inductive) @ AC 250 V
	Connection supply	2 leads 32" [0.9 m], 18 AWG with 3/8" NPT flex connector
	Connection auxiliary switch	cable 32" [0.9 m], 18 AWG appliance cable with 3/8" NPT flex connector
	Overload Protection	electronic throughout 0...95° rotation
	Electrical Protection	actuators are double insulated
	<b>Functional data</b>	Torque motor
Direction of motion motor		selectable by ccw/cw mounting
Direction of motion fail-safe		reversible with cw/ccw mounting
Angle of rotation		95°
Running Time (Motor)		15 s / 90°
Running time motor note		at rated voltage and torque 32...122°F [0...50°C]
Running time fail-safe		<15 s
Noise level, motor		45 dB(A)
Noise level, fail-safe		62 dB(A)
Position indication	Mechanical	
<b>Safety data</b>	Power source UL	Class 2 Supply
	Degree of protection IEC/EN	IP30
	Degree of protection NEMA/UL	NEMA 1
	Enclosure	UL Enclosure Type 1
	Agency Listing	cULus acc. to UL60730-1A/-2-14, CAN/CSA E60730-1:02 NYC Department of Buildings MEA 197-07-M California State Fire Marshal Listing 3210-1593:102
	Quality Standard	ISO 9001

**Technical data**

<b>Safety data</b>	UL 2043 Compliant	Suitable for use in air plenums per Section 300.22(C) of the NEC and Section 602 of the IMC
	Ambient humidity	Max. 95% RH, non-condensing
	Ambient temperature	32...122°F [0...50°C ]
	Storage temperature	-40...176°F [-40...80°C]
	Servicing	maintenance-free
<b>Weight</b>	Weight	3.8 lb [1.7 kg]
<b>Materials</b>	Housing material	galvanized steel
<b>Footnotes</b>	† UL File XAPX.E108966	

**Safety notes**

- \* Neither UL nor Belimo require individual fusing of FSLF actuators.
- The FSLF draws higher peak current when driving against its end stop or any other type of stop. Given the technology of fuses & breakers, this requires the value of fuse or breaker to be increased to avoid nuisance opening or tripping. A 1 A slow blow should be used for AC 24 V. A 0.25 A slow blow should be used for AC 120 V. A 0.125 A slow blow should be used for 230 V.
- SAFETY NOTES
- Wiring and installation must comply with all local electrical and mechanical codes.
- The actuator contains no components which the user can replace or repair.
- Cables are not plenum rated and require flex conduit.
- 1/2" Threaded Connector: Screw a conduit fitting into the actuator's metal bushing. Jacket the actuator's input wiring with suitable flexible conduit. Properly terminate the conduit in a suitable junction box.
- 3/8" Flex Connector (-FC models): Mount the flexible conduit into the actuator's metal bushing by means of the provided screw with a torque of 10 in-lb [1.2 Nm]. Jacket the actuator's input wiring with suitable flexible conduit. Properly terminate the conduit in a suitable junction box.

**Product features**

<b>Application</b>	The FS series of spring-return actuators are designed for the operation of UL555 and UL555S listed fire/smoke dampers in ventilation and air-conditioning systems.
<b>Operation</b>	The actuator is mounted in its fail safe position with the damper blade(s) typically closed. Upon applying power, the actuator drives the damper to the open position. The internal spring is tensioned at the same time. If the power supply is interrupted, the spring moves the damper back to its fail-safe position.
<b>Typical specification</b>	All smoke and combination fire and smoke dampers shall be provided with Belimo FSTF, FSLF, FSNF, or FSAF series actuators. All substitutions must be approved before submission of bid. Damper and actuator shall have UL555S Listing for 250°F and/or 350°F. Actuator shall have been tested to UL2043 per requirements of IMC 602.2 and NEC 300.22 (c). Where position indication is required -S models with auxiliary switches shall be provided.

**Accessories**







Electrical accessories	Description	Type
	Thermoelectric tripping device, Duct inside temperature 165°F	BAE165 US
	Auxiliary switch 2x SPDT	S2A-F US
Mechanical accessories	Description	Type
	Weather shield 13x8x6" [330x203x152 mm] (LxWxH)	ZS-100

Accessories

Description	Type
Weather shield 406x213x102 mm [16x8-3/8x4"] (LxWxH)	ZS-150

Electrical installation

 **APPLICATION NOTES**

-  Provide overload protection and disconnect as required.
-  Actuators may be powered in parallel. Power consumption must be observed.
-  S4 makes to S6 when actuator is powered open.
-  Auxiliary switches are for end position indication or interlock control.
-  Double insulated.
-  Ground present on some models.

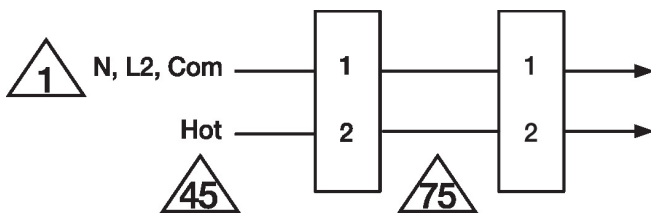

Parallel Actuator Wiring

Wiring diagrams

AC 24 V

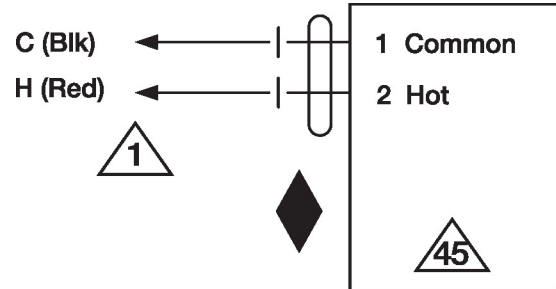

Typical containment damper control wiring  
Detector or relay F&S Damper

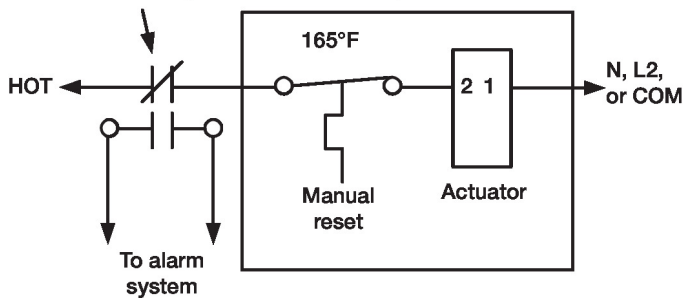

Electrical installation

Wiring diagrams

Parallel Actuator Wiring

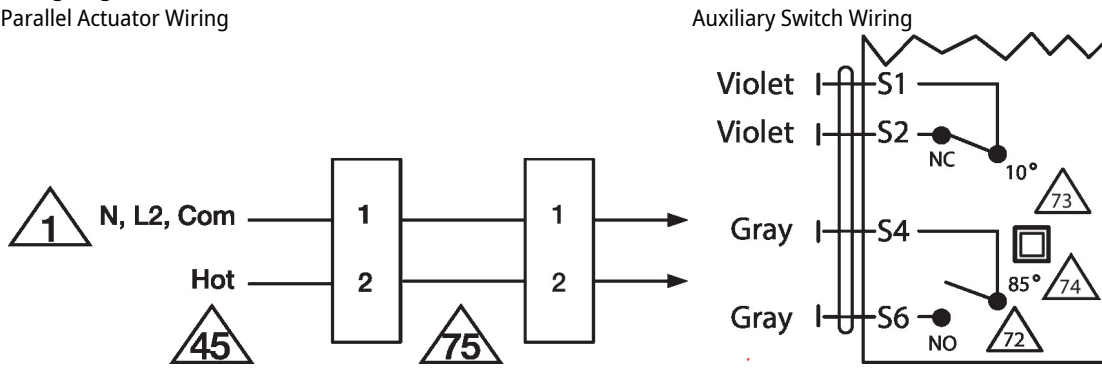

Dimensions

